



Use of the specification and guidelines in the example of the ENCR/JRC Data Call 2022

Tina Žagar, Slovenian Cancer Registry

eArchiving Initiative training webinar



REPUBLIC OF SLOVENIA
MINISTRY OF CULTURE
ARCHIVES OF THE REPUBLIC OF SLOVENIA



ONKOLOŠKI INŠTITUT
INSTITUTE OF ONCOLOGY
LJUBLJANA



CANCER REGISTRY
REGISTER RAKA
SLOVENIJA



European
Commission

ENCR/JRC Data Call 2022



- Every year European cancer registries are invited to submit data
- ECIS – European Cancer Information System (<https://ecis.jrc.ec.europa.eu/>)

Explore the data

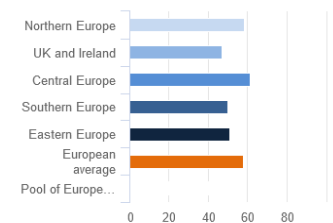
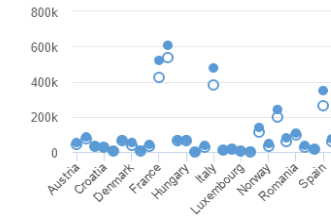
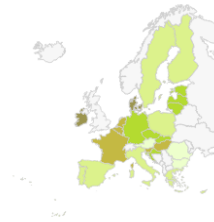

Incidence and mortality estimates 2022

National estimates of cancer incidence and mortality in 2022, for the major cancer sites in European countries.

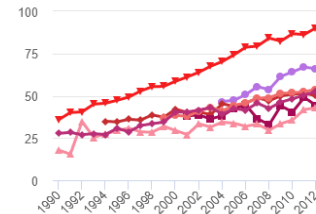

Incidence and mortality historical data

Incidence and mortality statistics over time by cancer site and demographic variables, in European cancer registration areas.

Long-term incidence and mortality estimates up to 2040

National estimates of cancer incidence and mortality up to 2040, for the major cancer sites in EU and EFTA countries, according to different projected populations.

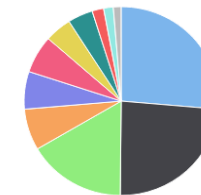

Childhood incidence historical data

Childhood incidence statistics by diagnostic group in European cancer registration areas.

Survival estimates

Estimated indicators of survival, by cancer sites and sex, across European countries and regions.

Process diagram for the export of CR data

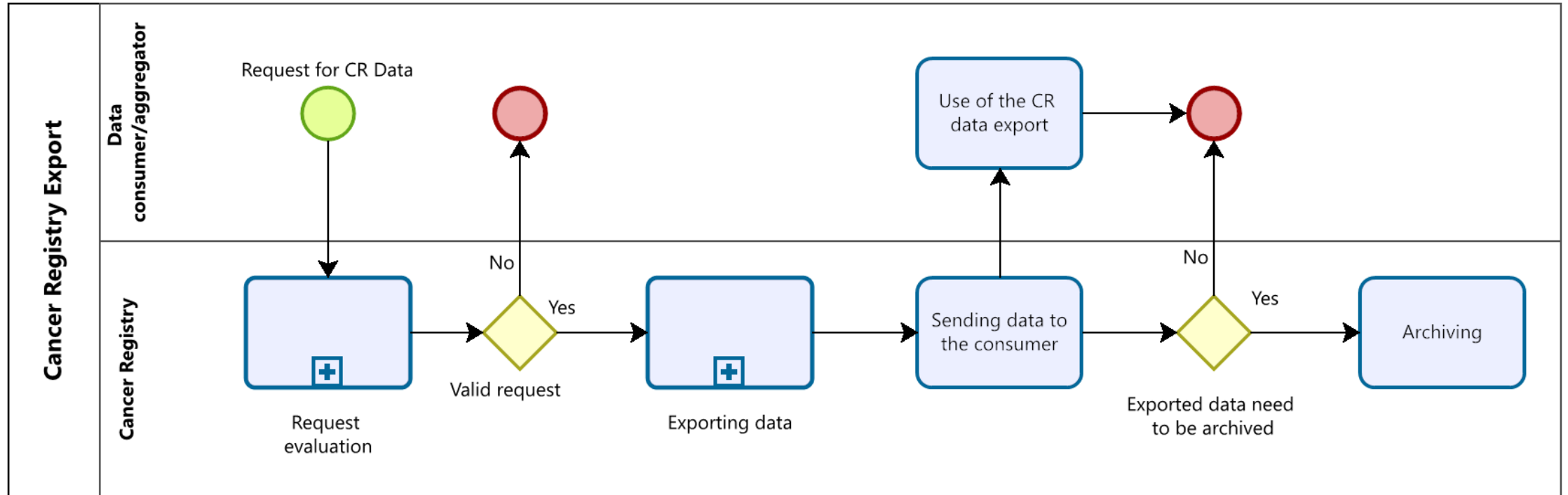

Request evaluation

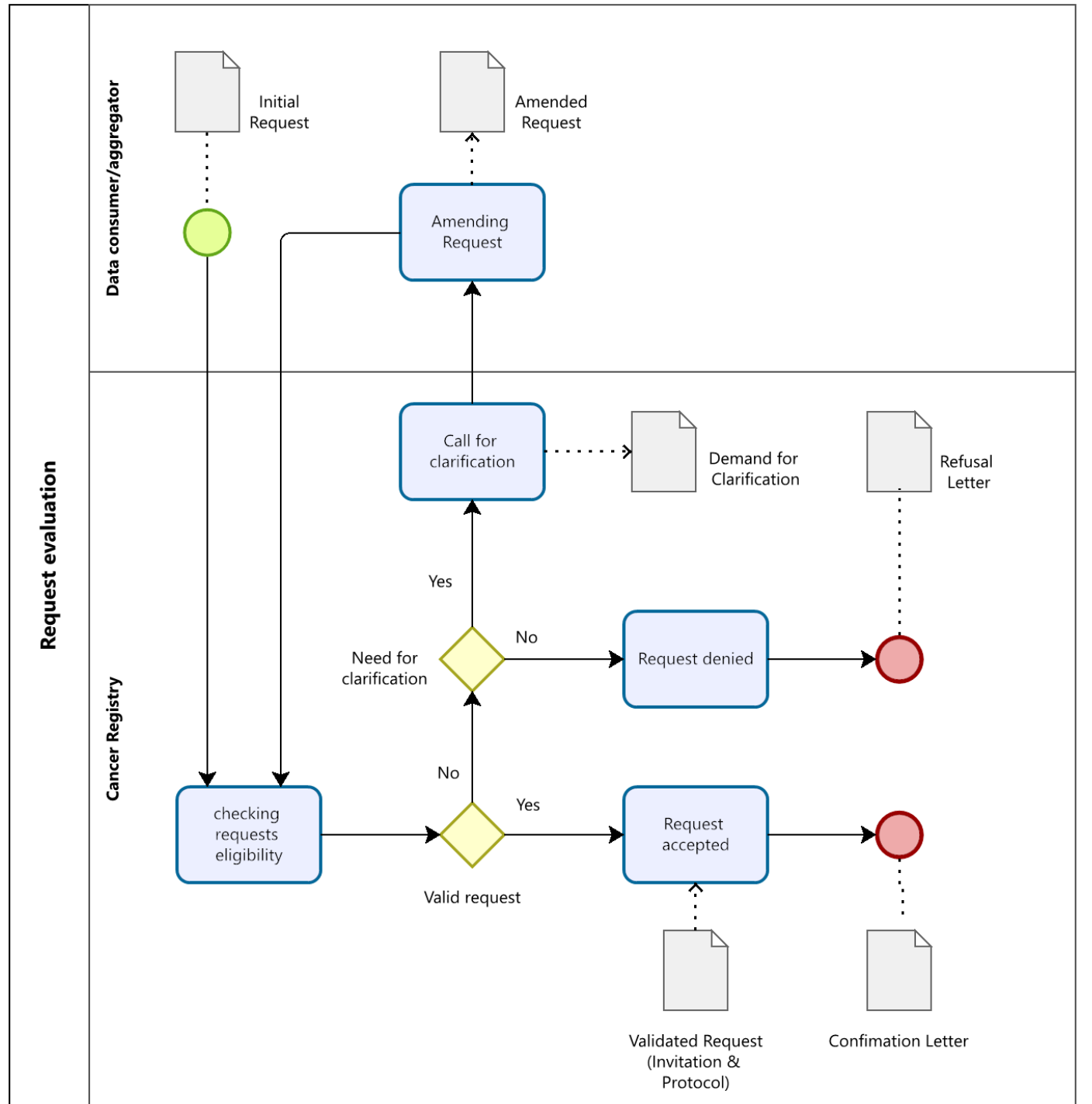
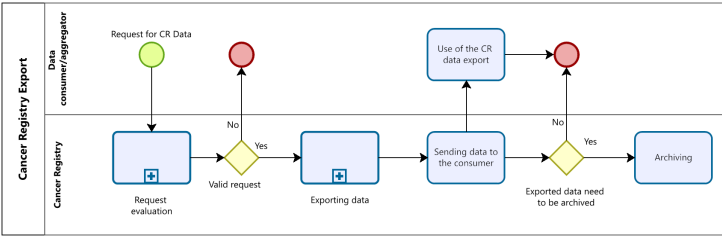

Exporting data

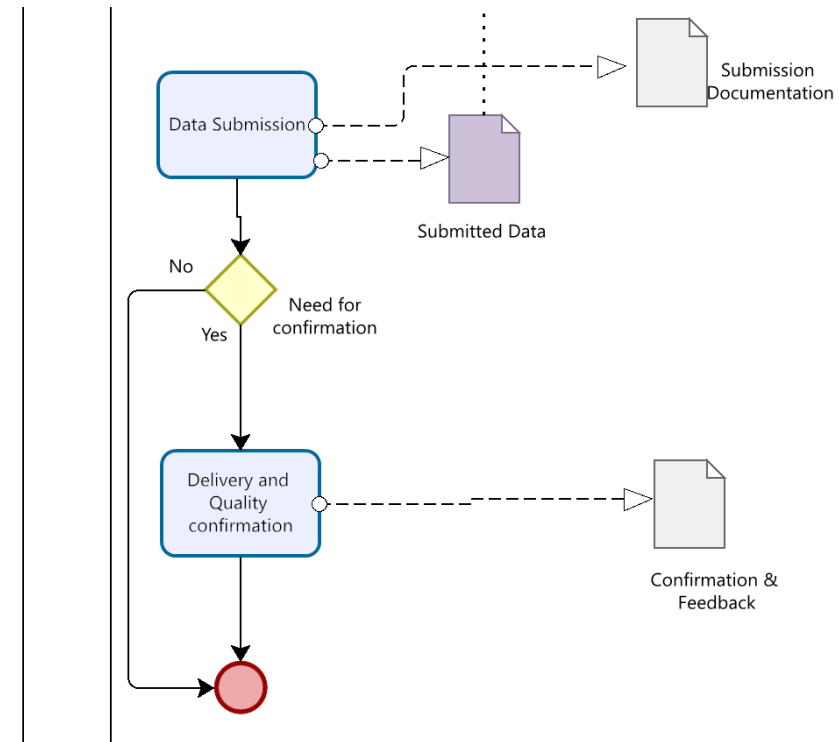
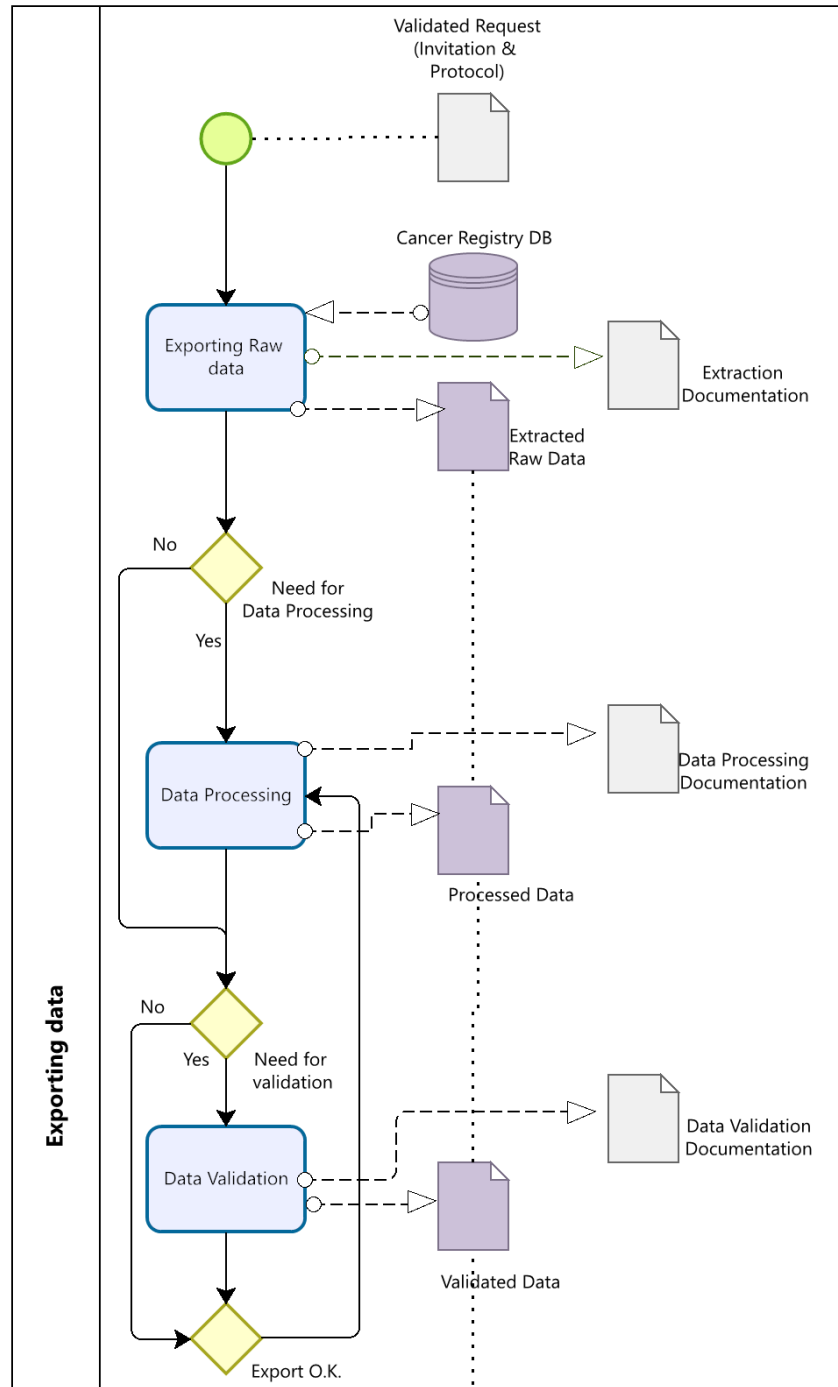
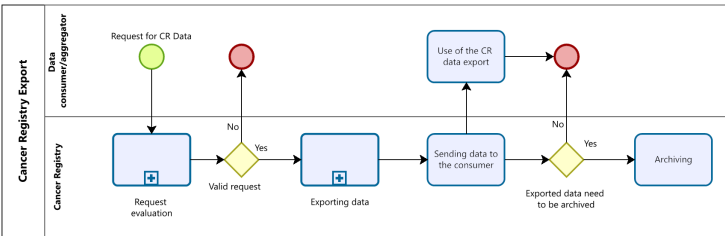

Content and structure of the Submission Information Package (SIP)

Representations

encompassing data extracted from the CR and supplementary information requested by data aggregators

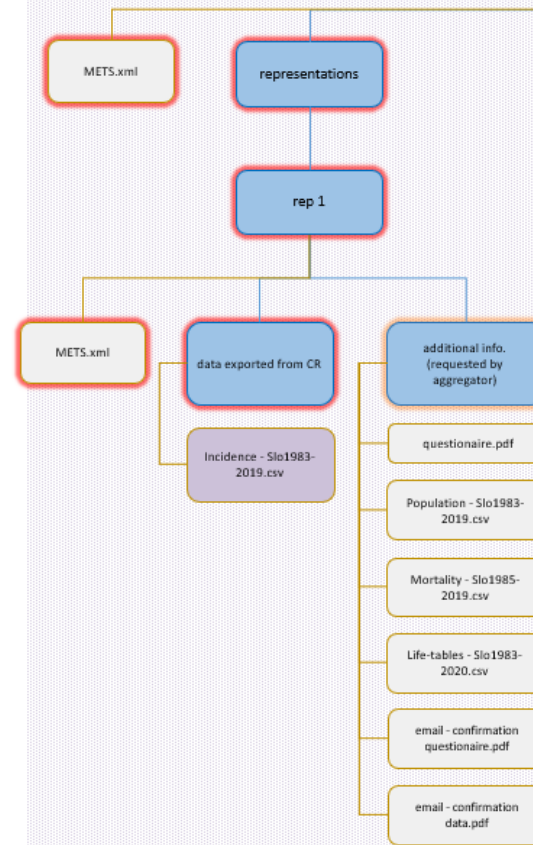

Documentation

which outlines the export process and is generated during the export

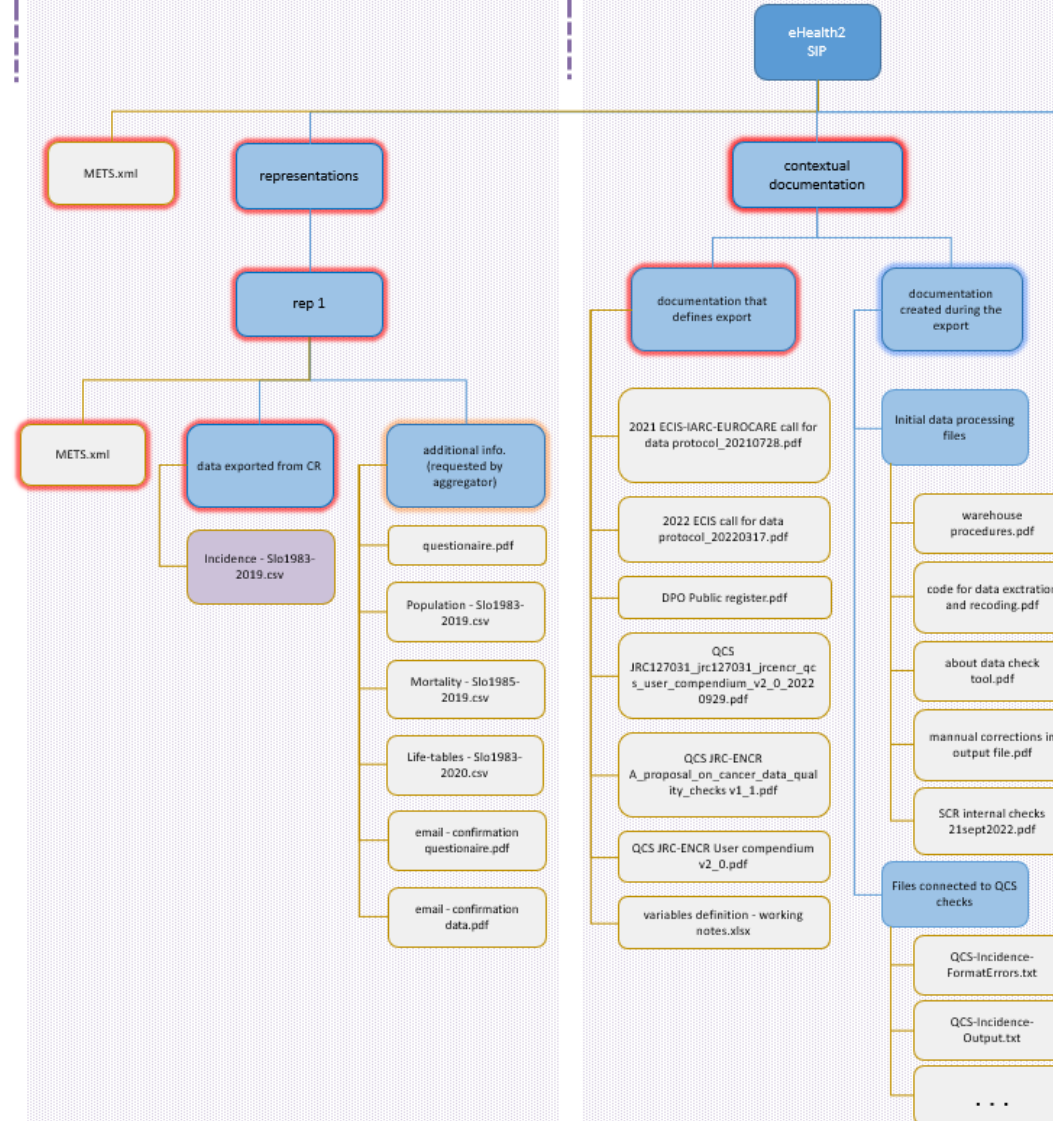

Metadata

comprising descriptive and preservation-related data



Used labeling

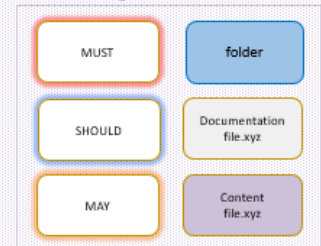

Documentation that defines export

- Invitation letter
- Protocol for data call
- QCS JRC-ENCR User compendium v2.0
- A proposal on cancer data quality checks
- <https://ecis.jrc.ec.europa.eu/>

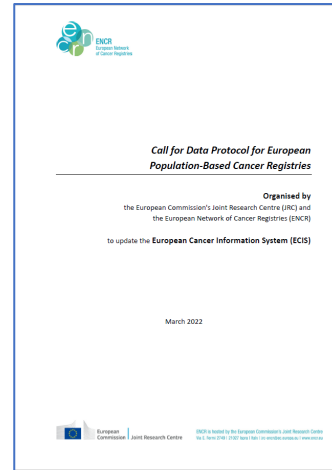
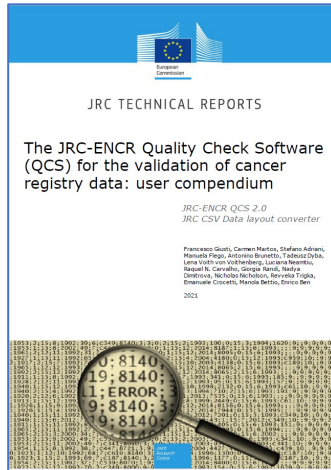
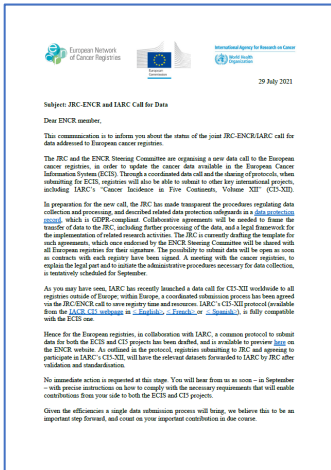
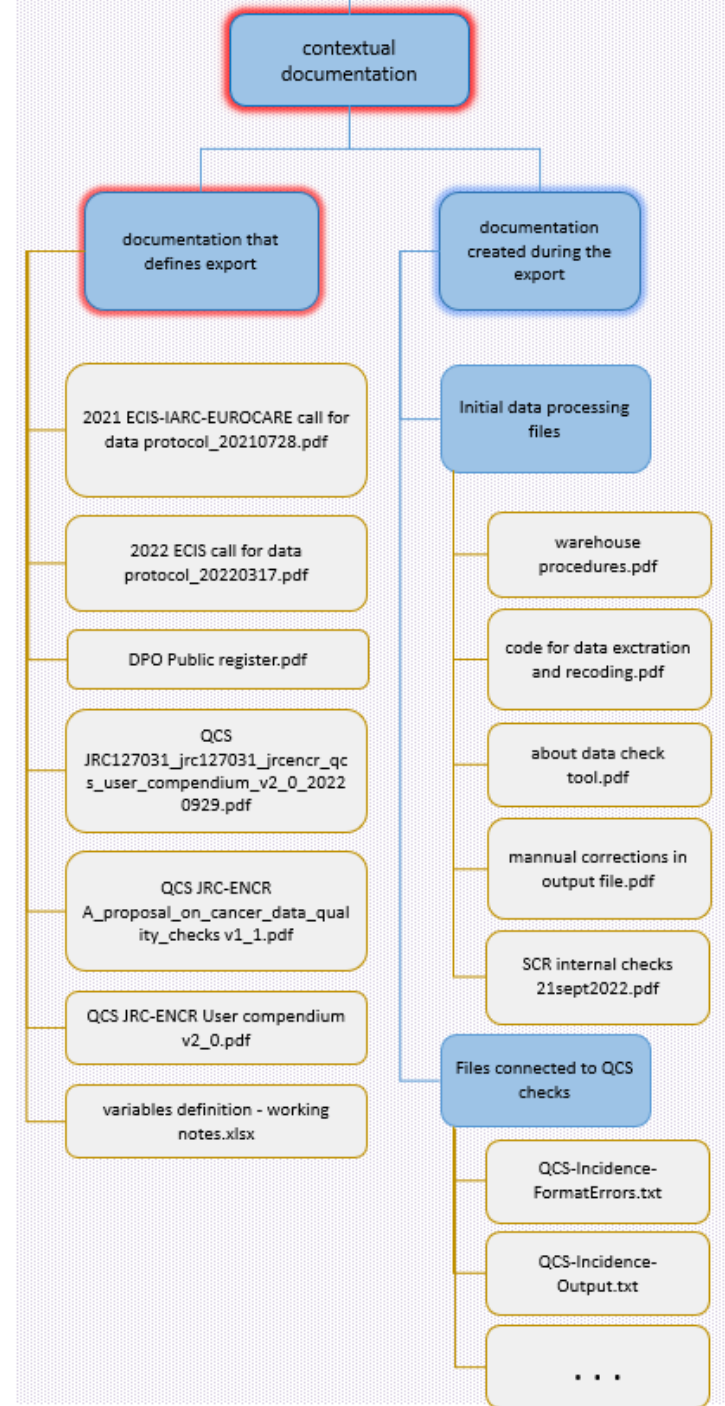

Documentation created during the export

- Code for extracting data from CR's database
- Intermediate steps of preparing the data from CR's database (e.g. results from QCS)

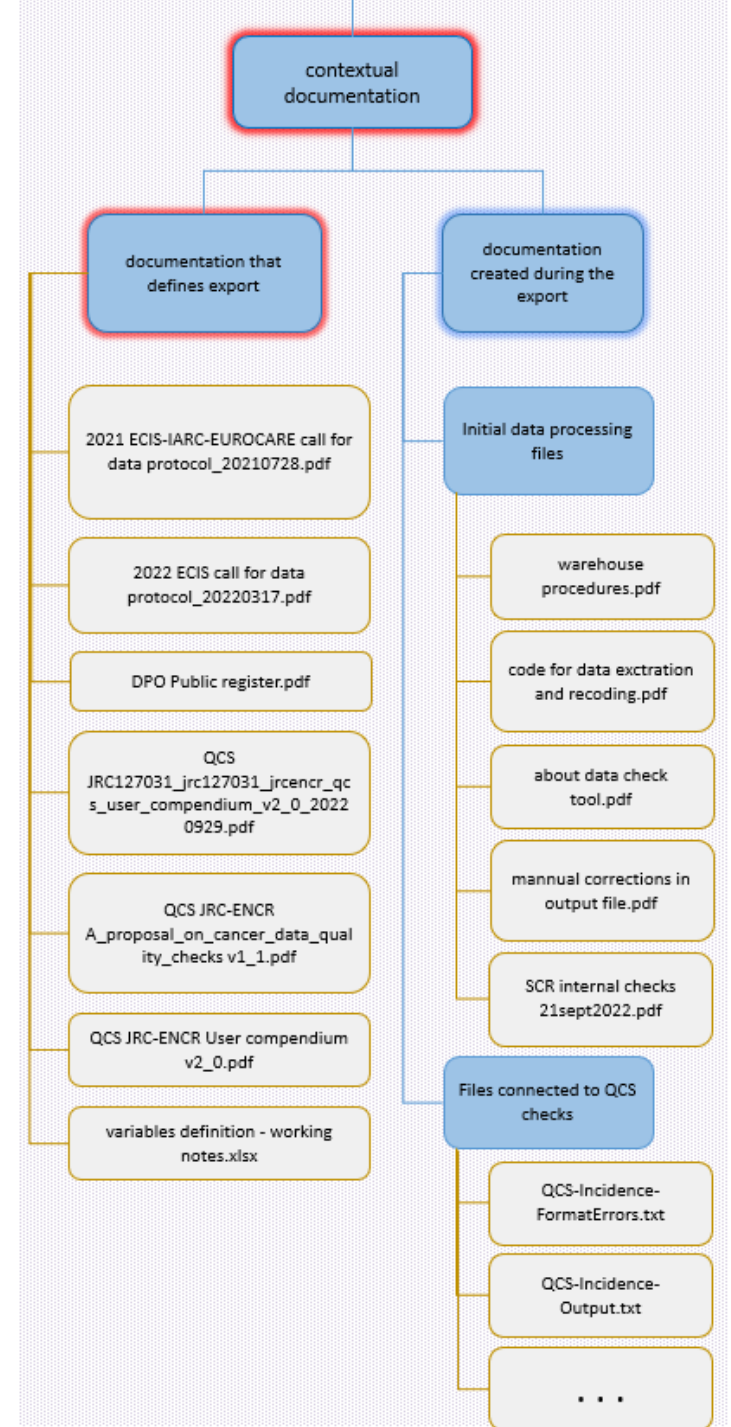

Additional info requested by aggregator

- Questionnaire
- e-mails (e.g. additional questions, confirmation for data submission)
- Data that are not information on cancer cases (population, mortality, life-tables)

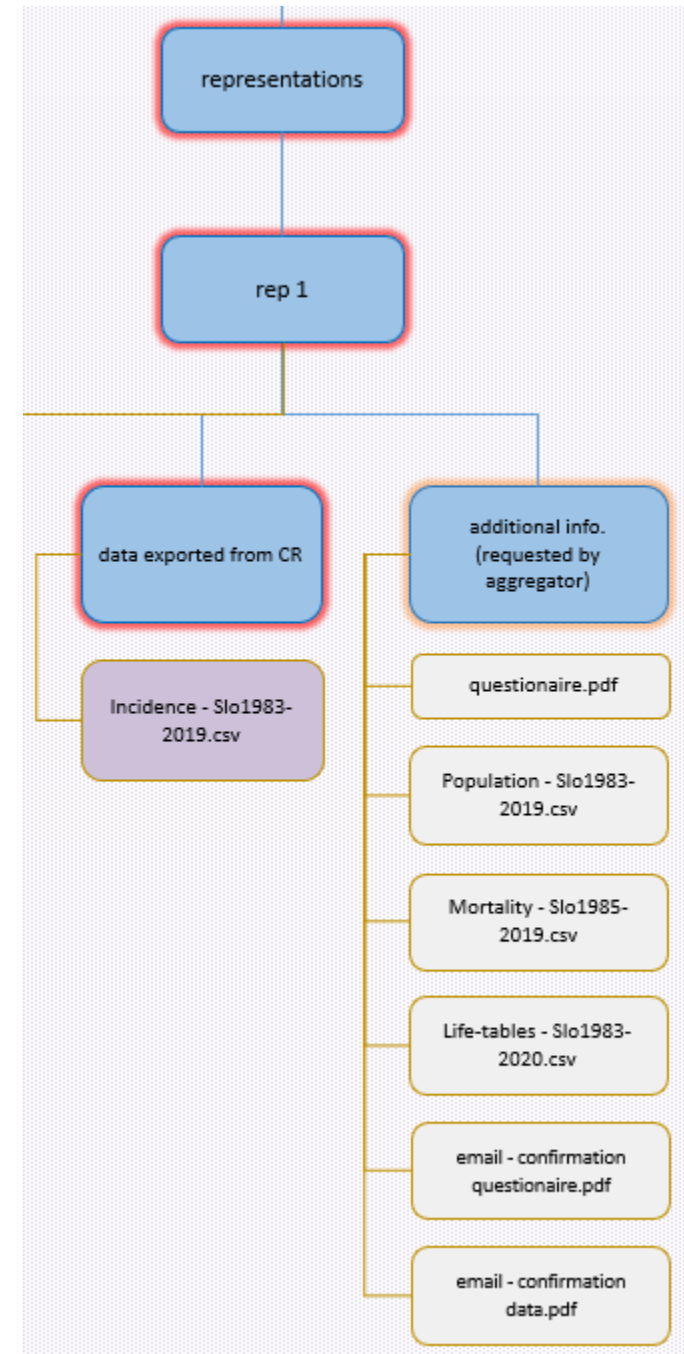

Data exported from CR

- Cancer incidence file

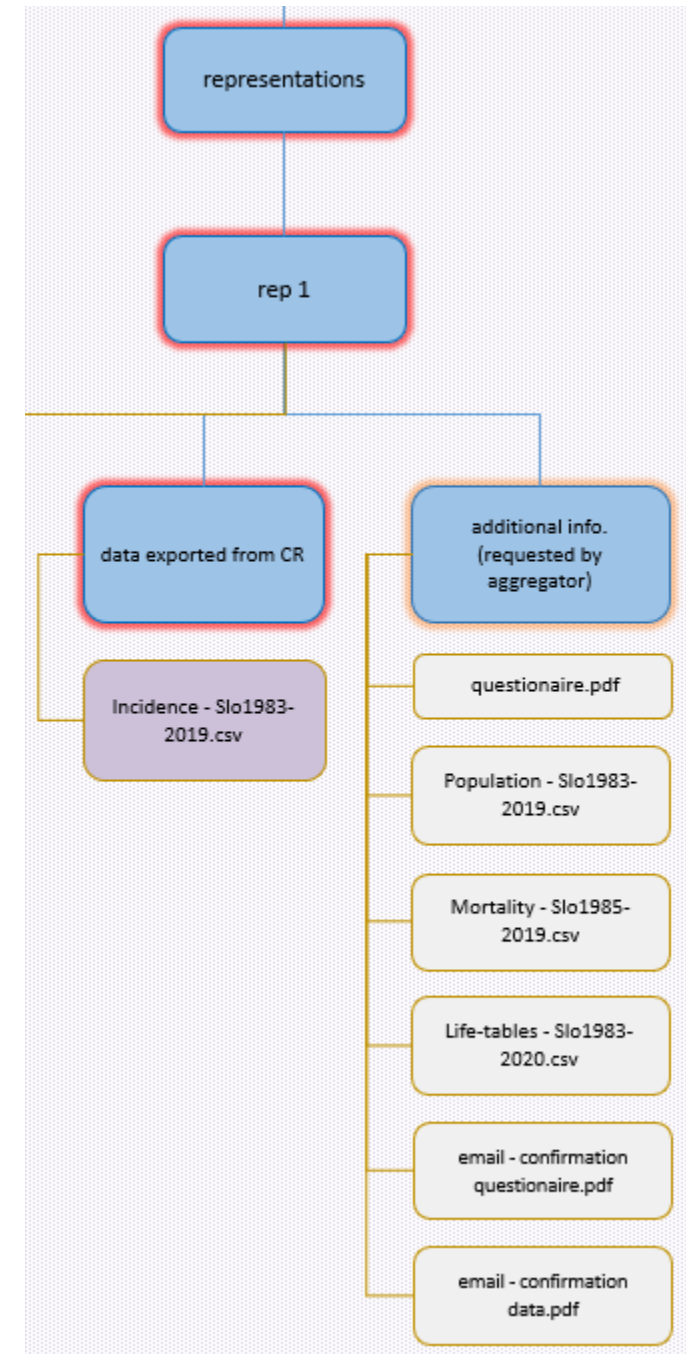

Additionally ...

List of files

Folder level 1	Folder level 2	Folder level 3	Filename	description (SCR = Slovenian Cancer Registry)	Initial date	Final date
representations	rep1	additional info. (requested by aggregator)	0 questionnaire.pdf	Filled in Questionnaire	16.09.2022	05.10.2022
representations	rep1	additional info. (requested by aggregator)	2 Population - Slo1983-2019.csv	Population file for years 1983-2019 prepared by SCR (data source is the Statistical Office RS), which was submitted to aggregator.	18.09.2022	30.09.2022
representations	rep1	additional info. (requested by aggregator)	3 Mortality - Slo1985-2019.csv	Mortality file for years 1983-2019 prepared by SCR (data source is the National Institute for Public Health), which was submitted to aggregator.	18.09.2022	30.09.2022
representations	rep1	additional info. (requested by aggregator)	4 Life-tables - Slo1983-2020.csv	File with life-tables for years 1983-2019 prepared by SCR, which was submitted to aggregator.	18.09.2022	30.09.2022
representations	rep1	additional info. (requested by aggregator)	email - confirmation questionnaire.pdf	Email converted to PDF format. Filled in Questionnaire - confirmation email.	05.10.2022	05.10.2022
representations	rep1	additional info. (requested	email - confirmation data.pdf	Email converted to PDF format. Confirmation of data submission.	30.09.2022	30.09.2022
representations	rep1	data exported from CR	1 Incidence - Slo1983-2019.csv	Cancer case file for incidence years 1983-2019 exported from SCR and submitted to ENCR datacall.	30.09.2022	30.09.2022

Thank you



© European Union 2020

Unless otherwise noted the reuse of this presentation is authorised under the [CC BY 4.0](https://creativecommons.org/licenses/by/4.0/) license. For any use or reproduction of elements that are not owned by the EU, permission may need to be sought directly from the respective right holders.